



## GaAs PHEMT MMIC LNA w/ FAILSAFE BYPASS MODE, 1700 - 2200 MHz

### Typical Applications

The HMC669LP3(E) is ideal for:

- Cellular/3G and LTE/WiMAX/4G
- BTS & Infrastructure
- Repeaters and Femtocells
- Tower Mounted Amplifiers
- Test & Measurement Equipment

### Features

- Noise Figure: 1.4 dB
- Output IP3: +29 dBm
- Gain: 17 dB
- Fail-safe Operation:
  - Bypass is enabled when LNA is unpowered
- Single Supply: +3V or +5V
- 16 Lead 3x3mm QFN Package: 9 mm<sup>2</sup>

### Functional Diagram

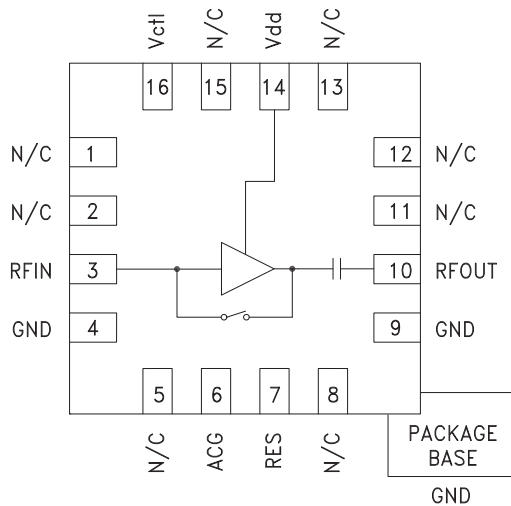

### General Description

The HMC669LP3(E) is a versatile, high dynamic range GaAs MMIC Low Noise Amplifier that integrates a low loss LNA bypass mode on the IC. The amplifier is ideal for receivers and LNA modules operating between 1.7 and 2.2 GHz and provides 1.4 dB noise figure, 17 dB of gain and +29 dBm IP3 from a single supply of +5V @ 86mA. Input and output return losses are excellent and no external matching components are required. A single control line is used to switch between LNA mode and a low loss bypass mode. Fail-safe topology also enables the LNA bidirectional bypass path when no DC power is available.

### Electrical Specifications, $T_A = +25^\circ C$ , $R_{bias} = 15 \text{ Ohm}$

Parameter	LNA Mode						Bypass Mode			Fail-safe Mode			Units	
	Vdd = +3V			Vdd = +5V			Min.	Typ.	Max.	Min.	Typ.	Max.		
	Min.	Typ.	Max.	Min.	Typ.	Max.								
Frequency Range	1.7 - 2.2			1.7 - 2.2			1.7 - 2.2			1.7 - 2.2			GHz	
Gain	12	15		14	17		-3	-2.1		-3	-2.1		dB	
Gain Variation Over Temperature	0.015			0.014			0.0008			0.0008			dB / °C	
Noise Figure	1.4			1.65									dB	
Input Return Loss	10			11			12			12			dB	
Output Return Loss	13			13			12			12			dB	
Reverse Isolation	28			30			-			-			dB	
Power for 1dB Compression (P1dB) <sup>[1]</sup>	11.5			12			21			24			dBm	
Third Order Intercept (IP3) <sup>[2]</sup>	25			29			25			25			dBm	
Supply Current (Idd)	49			59			86			105			0.04	mA
Switching Speed														
LNA Mode to Bypass Mode							80			-			ns	
Bypass Mode to LNA Mode	100			100									ns	

[1] P1dB for LNA Mode is referenced to RFOUT while P1dB for Bypass and Fail-safe Modes are referenced to RFIN.

[2] IP3 for LNA Mode is referenced to RFOUT while IP3 for Bypass and Fail-safe Modes are referenced to RFIN.

**LNA - Broadband Gain & Return Loss**

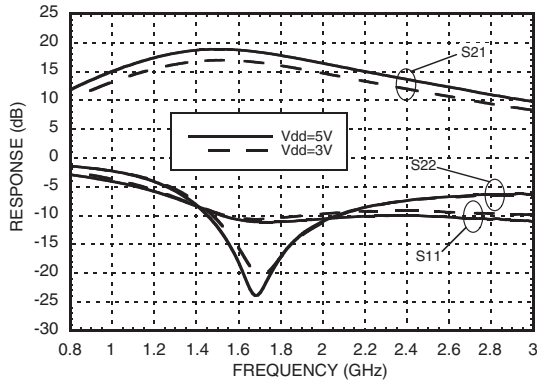

**LNA - Gain vs. Temperature [1]**

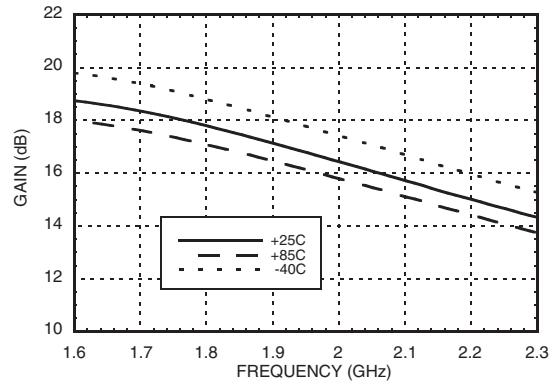

**LNA - Gain vs. Temperature [2]**

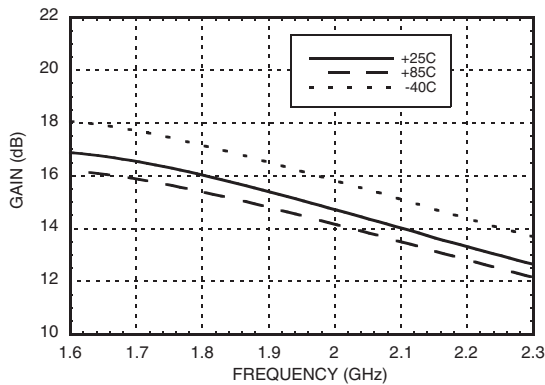

**LNA - Return Loss vs. Temperature [1]**

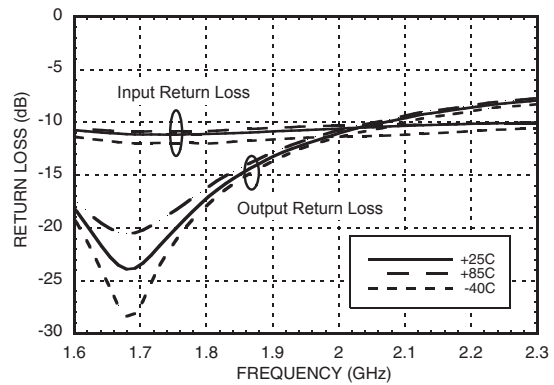

**LNA - Noise Figure vs. Temperature [3]**

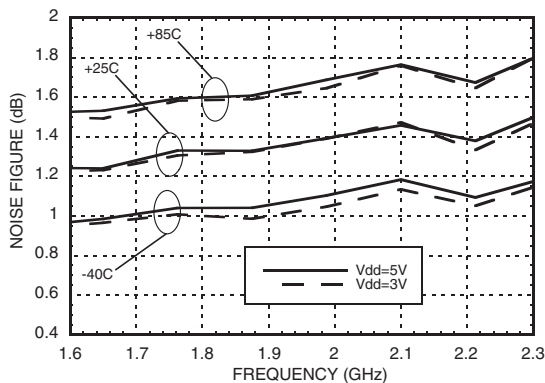

**LNA - Output IP3 vs. Temperature, Output Power @ 0 dBm**

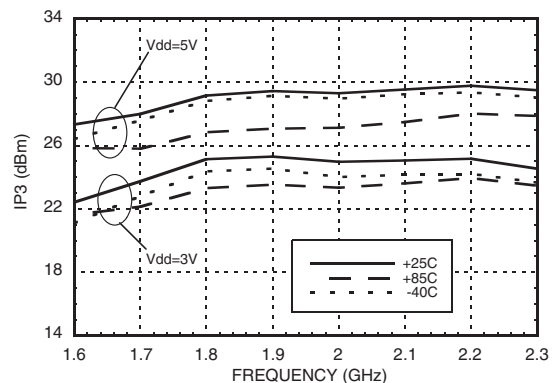

[1] Vdd = 5V [2] Vdd = 3V [3] Measurement reference plane shown on evaluation PCB drawing.

LNA - Output P1dB vs. Temperature <sup>[1]</sup>

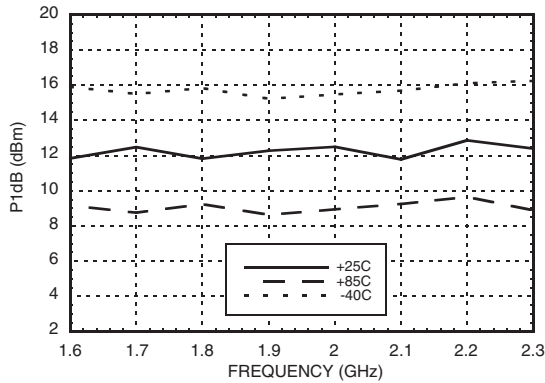

LNA - Output P1dB vs. Temperature <sup>[2]</sup>

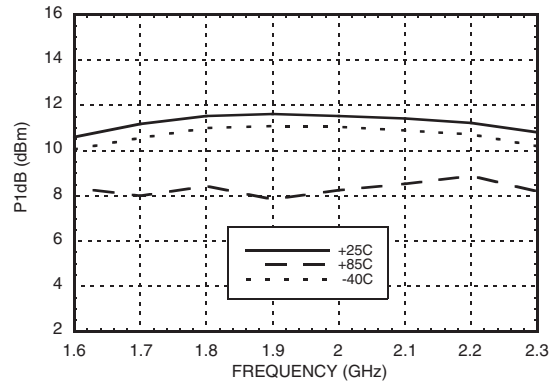

LNA - Gain, P1dB, Output IP3 vs. Current <sup>[1]</sup> @ 1900 MHz

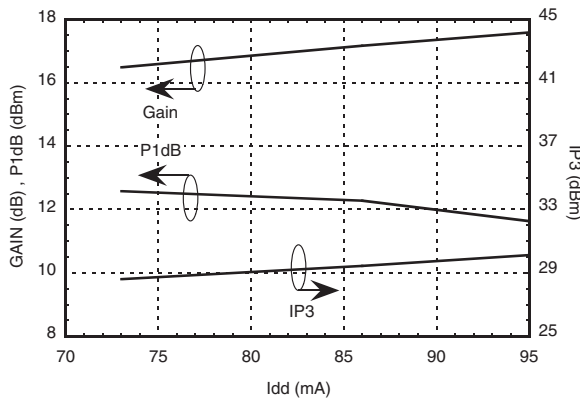

LNA - Gain, P1dB, Output IP3 vs. Current <sup>[2]</sup> @ 1900 MHz

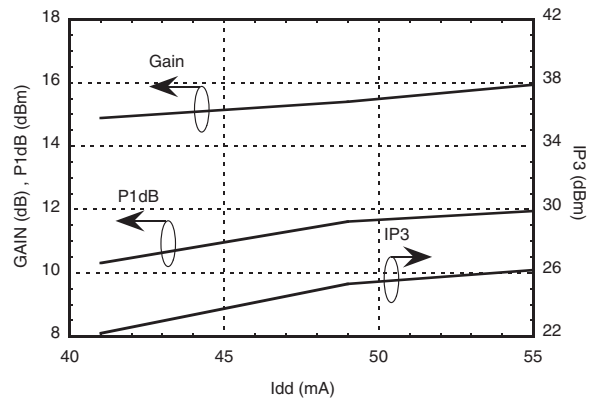

LNA - Reverse Isolation vs. Temperature <sup>[1]</sup>

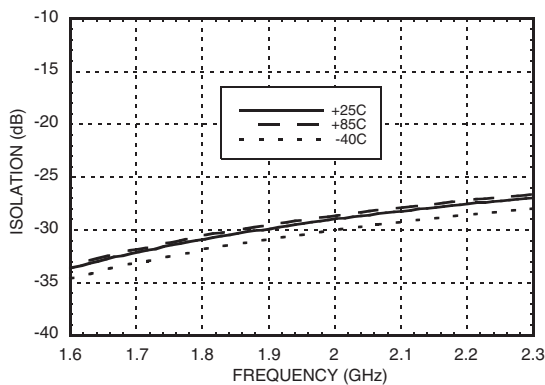

LNA - Output P1dB, Gain & Noise Figure <sup>[3]</sup> vs. Vdd @ 1900 MHz

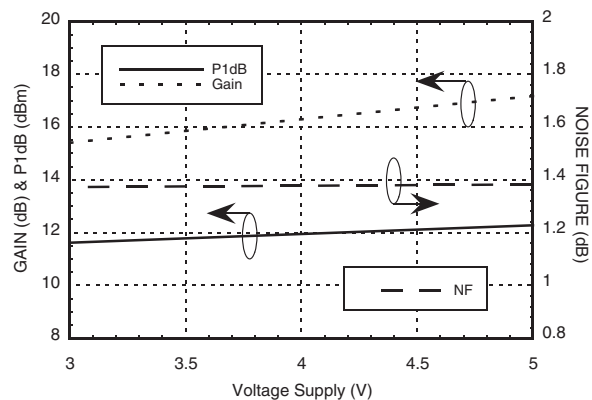

[1] Vdd = 5V [2] Vdd = 3V [3] Measurement reference plane shown on evaluation PCB drawing.

**Bypass Mode -  
Broadband Gain & Return Loss**

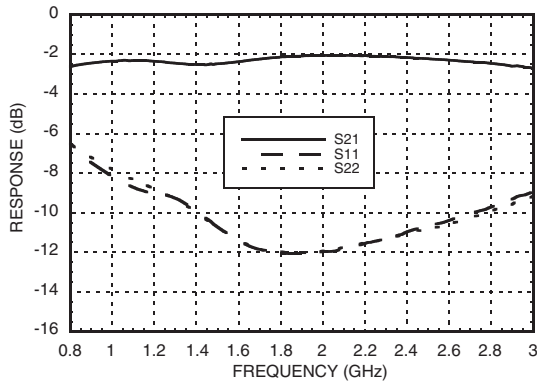

**Bypass Mode -  
Input IP3 vs. Output Power @ 1900 MHz**

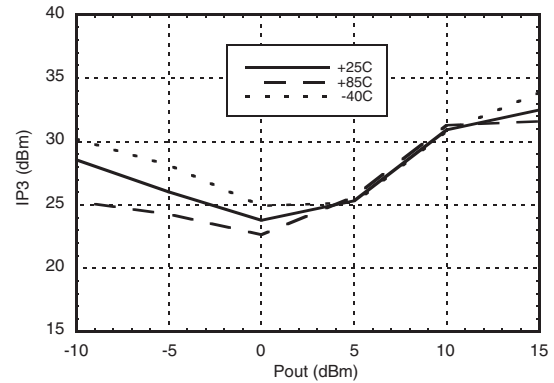

**Bypass Mode - Input IP3 vs.  
Temperature, Output Power @ 5 dBm**

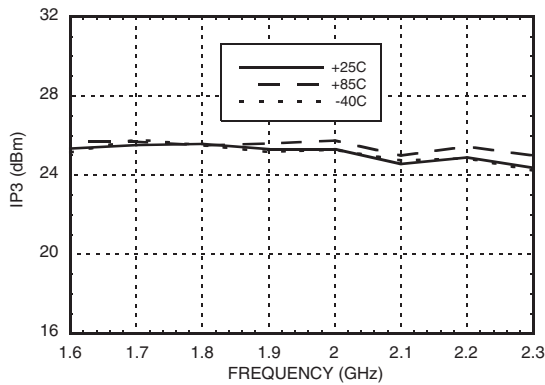

**Bypass Mode -  
Insertion Loss vs. Temperature**

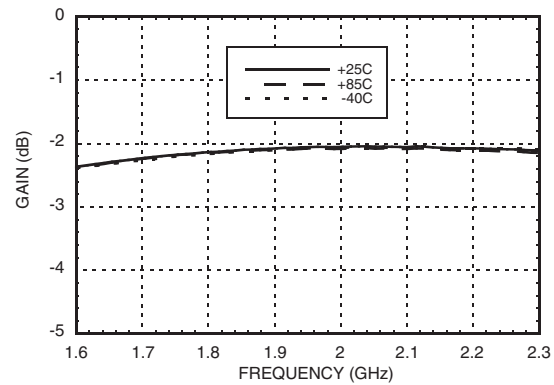

**Bypass Mode -  
Input Return Loss vs. Temperature**

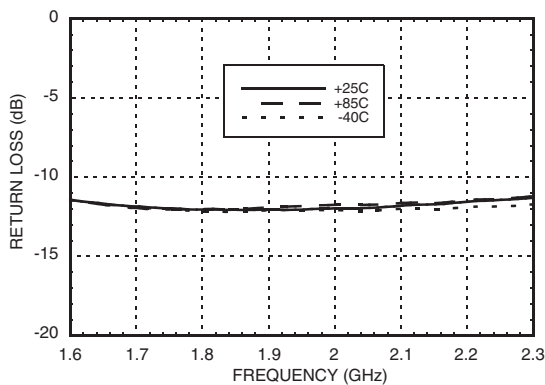

**Bypass Mode -  
Output Return Loss vs. Temperature**

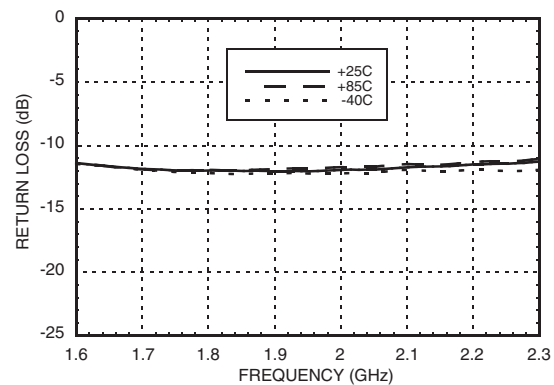

**Failsafe Mode -  
Broadband Gain & Return Loss**

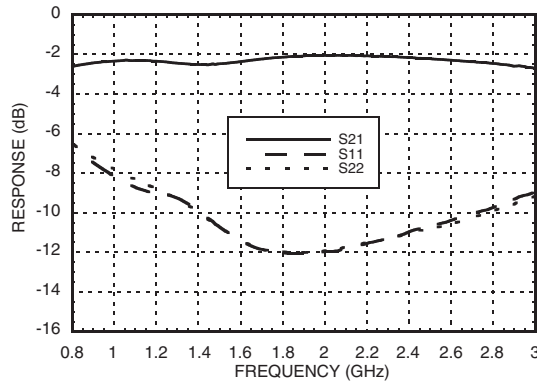

**Failsafe Mode -  
Input IP3 vs. Output Power @ 1900 MHz**

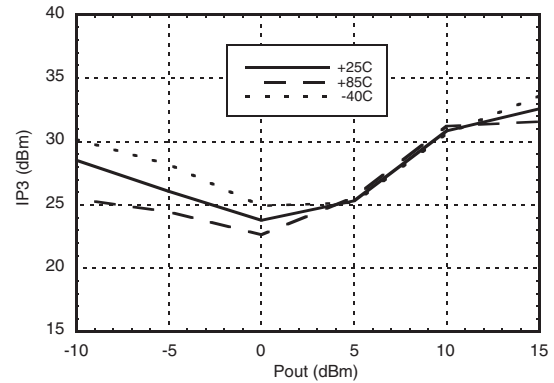

**Failsafe Mode - Input IP3 vs.  
Temperature, Output Power @ 5 dBm**

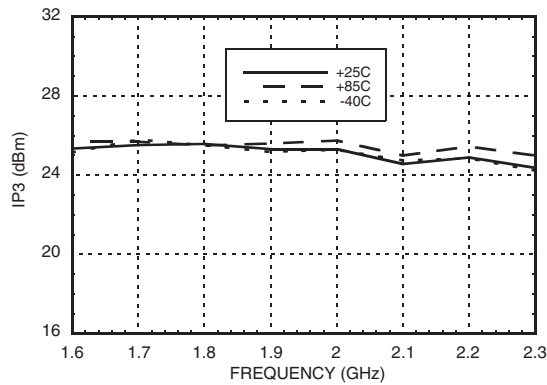

**Failsafe Mode -  
Insertion Loss vs. Temperature**

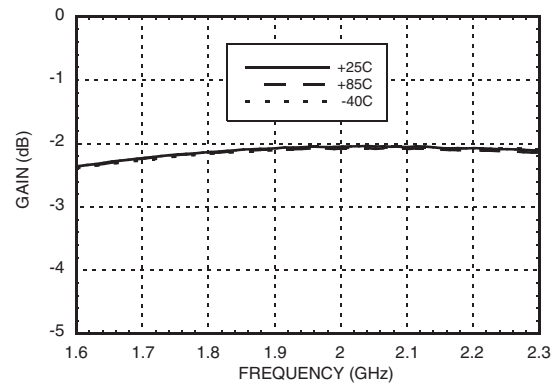

**Failsafe Mode -  
Input Return Loss vs. Temperature**

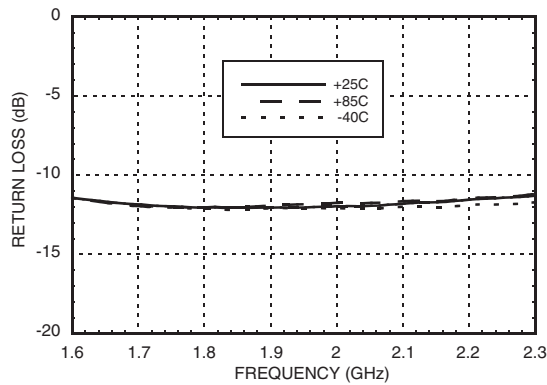

**Failsafe Mode -  
Output Return Loss vs. Temperature**

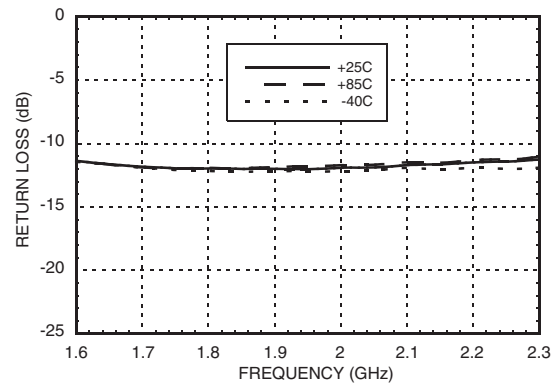



### Absolute Maximum Ratings

Drain Bias Voltage (Vdd)	+6 Vdc
Control Voltage (Vctl)	+6 Vdc
RF Input Power (RFIN)	LNA Mode +5 dBm Bypass / Fail safe Mode +20 dBm
Channel Temperature	150 °C
Continuous P <sub>diss</sub> (T = 85 °C) (derate 10.71 mW/°C above 85 °C)	0.70 W
Thermal Resistance (channel to ground paddle)	93.33 °C/W
Storage Temperature	-65 to +150° C
Operating Temperature	-40 to +85° C
ESD Sensitivity (HBM)	Class 1A

### Typical Supply Current vs. Vdd

R <sub>bias</sub> Ω	I <sub>dd</sub> (mA)	
	Vdd= 3V	Vdd= 5V
0	55	95
15	49	86
47	41	73
180 [1]	28	50

[1] Recommended maximum R<sub>bias</sub>

### Truth Table

LNA Mode	Vctl = Vdd = 3 to 5V
Bypass Mode	Vctl= 0V, Vdd = 3 to 5V
Failsafe Mode	Vctl = Vdd = N/C



ELECTROSTATIC SENSITIVE DEVICE  
OBSERVE HANDLING PRECAUTIONS



**Outline Drawing**

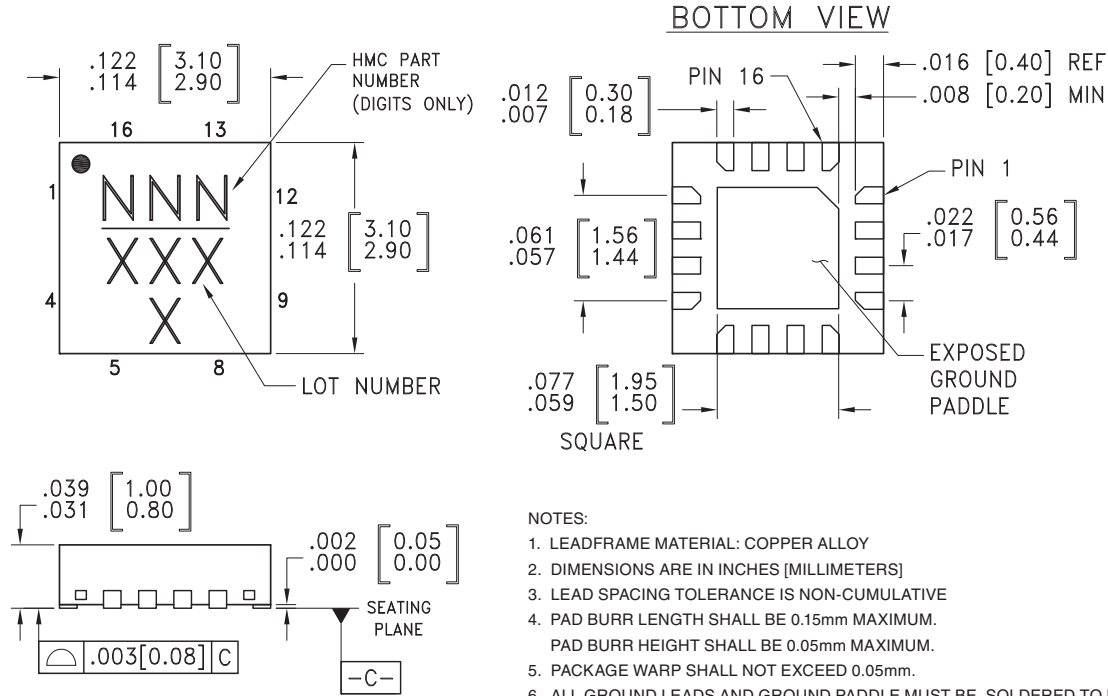

**Package Information**

Part Number	Package Body Material	Lead Finish	MSL Rating	Package Marking <sup>[3]</sup>
HMC669LP3	Low Stress Injection Molded Plastic	Sn/Pb Solder	MSL1 <sup>[1]</sup>	669 XXXX
HMC669LP3E	RoHS-compliant Low Stress Injection Molded Plastic	100% matte Sn	MSL1 <sup>[2]</sup>	669 XXXX

[1] Max peak reflow temperature of 235 °C  
 [2] Max peak reflow temperature of 260 °C  
 [3] 4-Digit lot number XXXX



### Pin Descriptions

Pin Number	Function	Description	Interface Schematic
1, 2, 5, 8, 11, 12, 13, 15	N/C	These pins are not connected internally; however, all data shown herein was measured with these pins connected to RF/DC ground externally.	
3	RFIN	This pin is DC coupled. Off-chip DC blocking capacitor required.	
4, 9	GND	These pins and the exposed ground paddle must be connected to RF/DC ground.	
6	ACG	AC Ground. Attach bypass capacitor per application circuit.	
7	RES	External resistor pin for current control. See table for external resistor value vs. bias current data.	
10	RFOUT	This pin is matched to 50 Ohms	
14	Vdd	Power Supply voltage pin. External bypass capacitors required.	
16	Vctl	Control voltage pin for LNA / Bypass Modes. Setting voltage equal to VDD enables LNA Mode. External Bypass capacitor required.	





#### Application Circuit

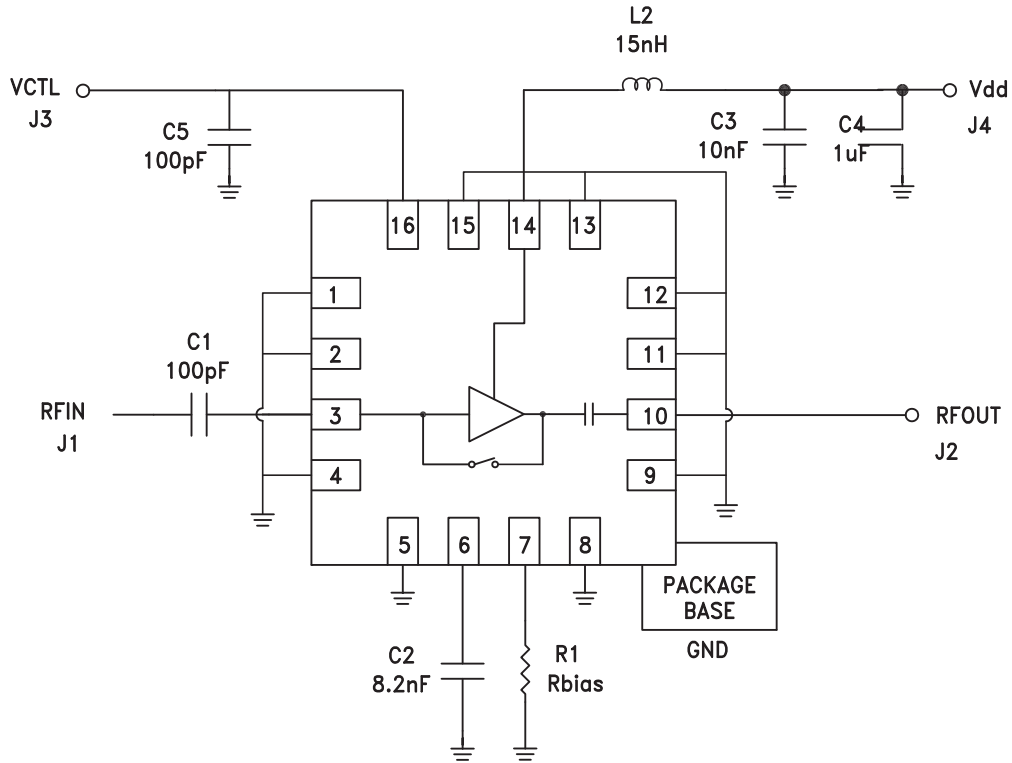

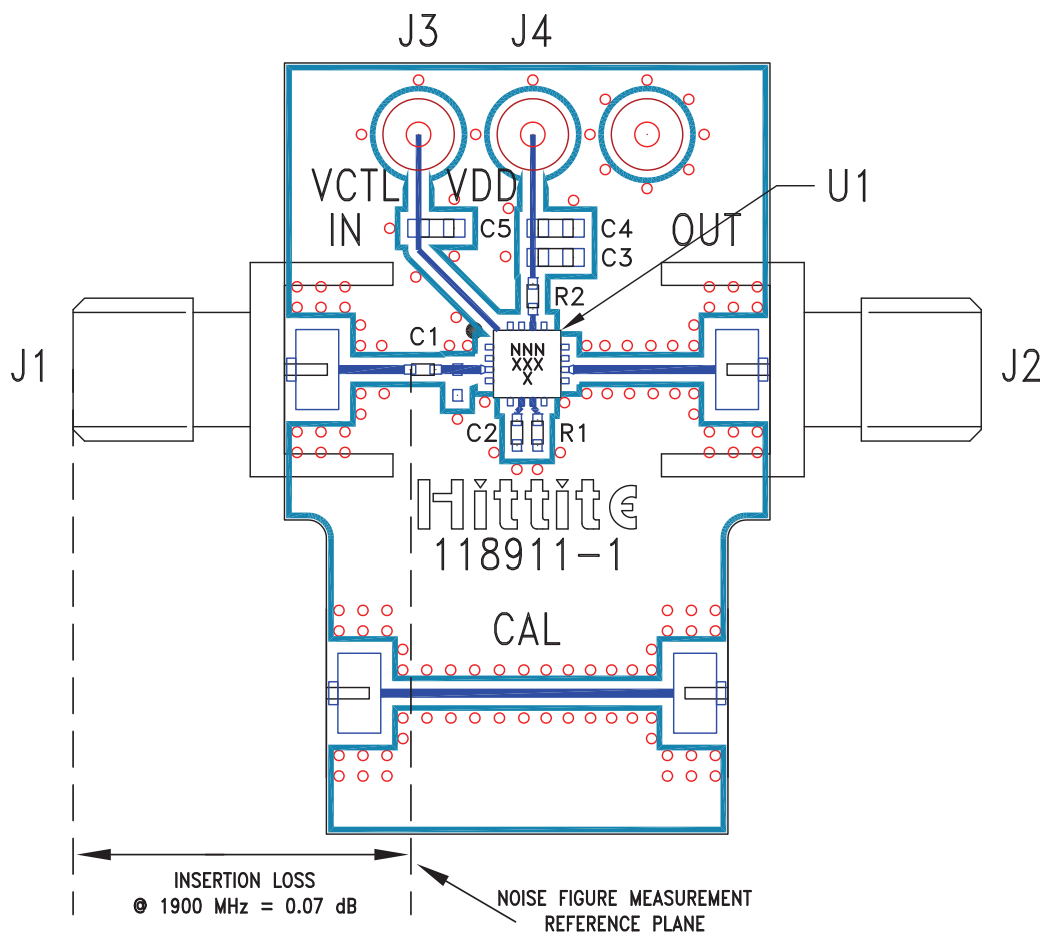
**Evaluation PCB**

**List of Materials for Evaluation PCB 121923 [1]**

Item	Description
J1 - J2	PCB Mount SMA Connector
J3 - J4	DC Pin
C1	82 pF Capacitor, 0402 Pkg.
C2	8200 pF Capacitor, 0402 Pkg.
C3	10 nF Capacitor, 0603 Pkg.
C4	1 $\mu$ F Capacitor, 0603 Pkg.
C5	100 pF Capacitor, 0603 Pkg.
R1	15 Ohm Resistor, 0402 Pkg.
R2	0 Ohm Resistor, 0402 Pkg.
U1	HMC669LP3(E) Amplifier
PCB [2]	118911 Evaluation Board

[1] Reference this number when ordering complete evaluation PCB

[2] Circuit Board Material: Rogers 4350

The circuit board used in the application should use RF circuit design techniques. Signal lines should have 50 Ohm impedance while the package ground leads and exposed paddle should be connected directly to the ground plane similar to that shown. A sufficient number of via holes should be used to connect the top and bottom ground planes. The evaluation circuit board shown is available from Hittite upon request.